



3DXpert™ for SOLIDWORKS®

Build Platform Arrangement

2D Nesting

14,0200,1599,1024(SP2)

In this exercise, we will learn how to create **2D Nesting** of parts on the tray.

When placing parts on tray, it might take time to find the best positioning and orientation in order to maximize the quantity of parts on the tray.

2D Nesting is the tool to shorten this time and to quickly get an idea of how many parts we can place on the tray.



The quantity of parts is influenced by the position and orientation of the part (use the Positioning Body command), which is one of the initial decisions we need to take when we prepare for 3D Printing.

In some cases, a good positioning for 3D printing may result in a better solution by having additional parts nested on tray.

At any time, the **2D Nesting** Calculation can be run, even if only for a quick analysis.

To use this command we need to follow a few steps (guided):

- Open the downloaded **3D Printing Project** from the Initial screen.
- **Note** that there is only 1 part on tray.
- Use the **2D Nesting** command to maximize and arrange the parts on tray.

<p style="font-size: 2em; margin: 0;">!</p> <p style="font-size: 1.2em; margin: 0;">Notice/ Remember</p>		Left mouse button name is " <i>pick</i> "
		Middle mouse button name is " <i>Exit</i> "
		Right mouse button name is " <i>Click</i> "

1. From the Initial screen **pick Open File**.

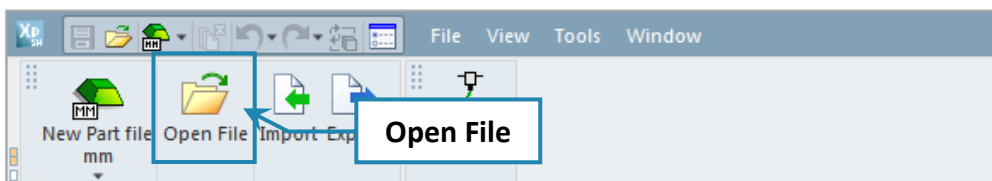

2. This command will open the **3DXpert for SOLIDWORKS Explorer**.

Load project file **3DP_2D Nesting Project.elt** from the same folder where you have downloaded the files.

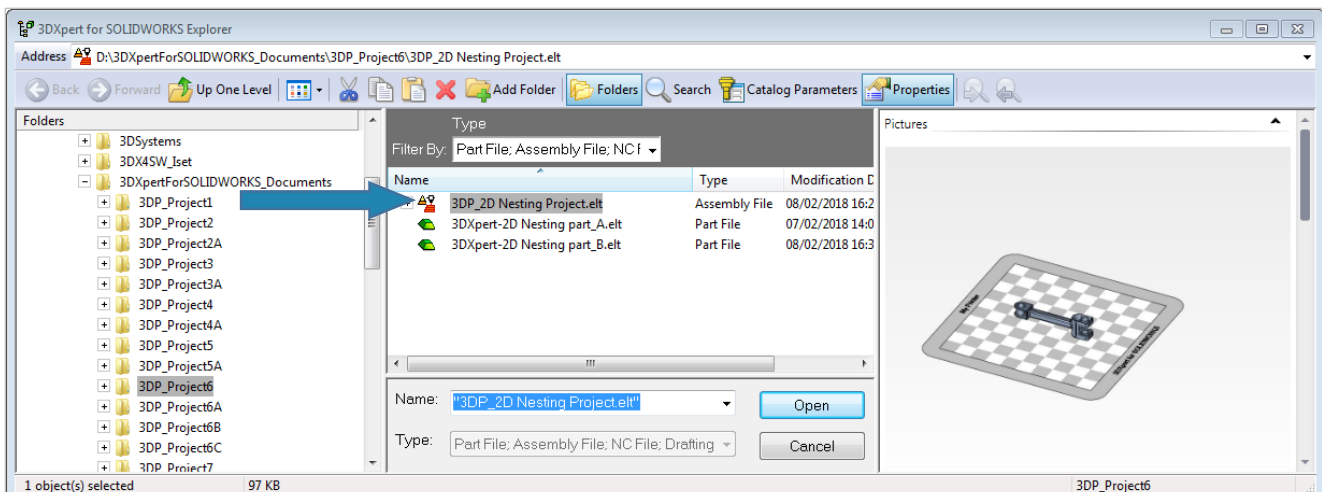



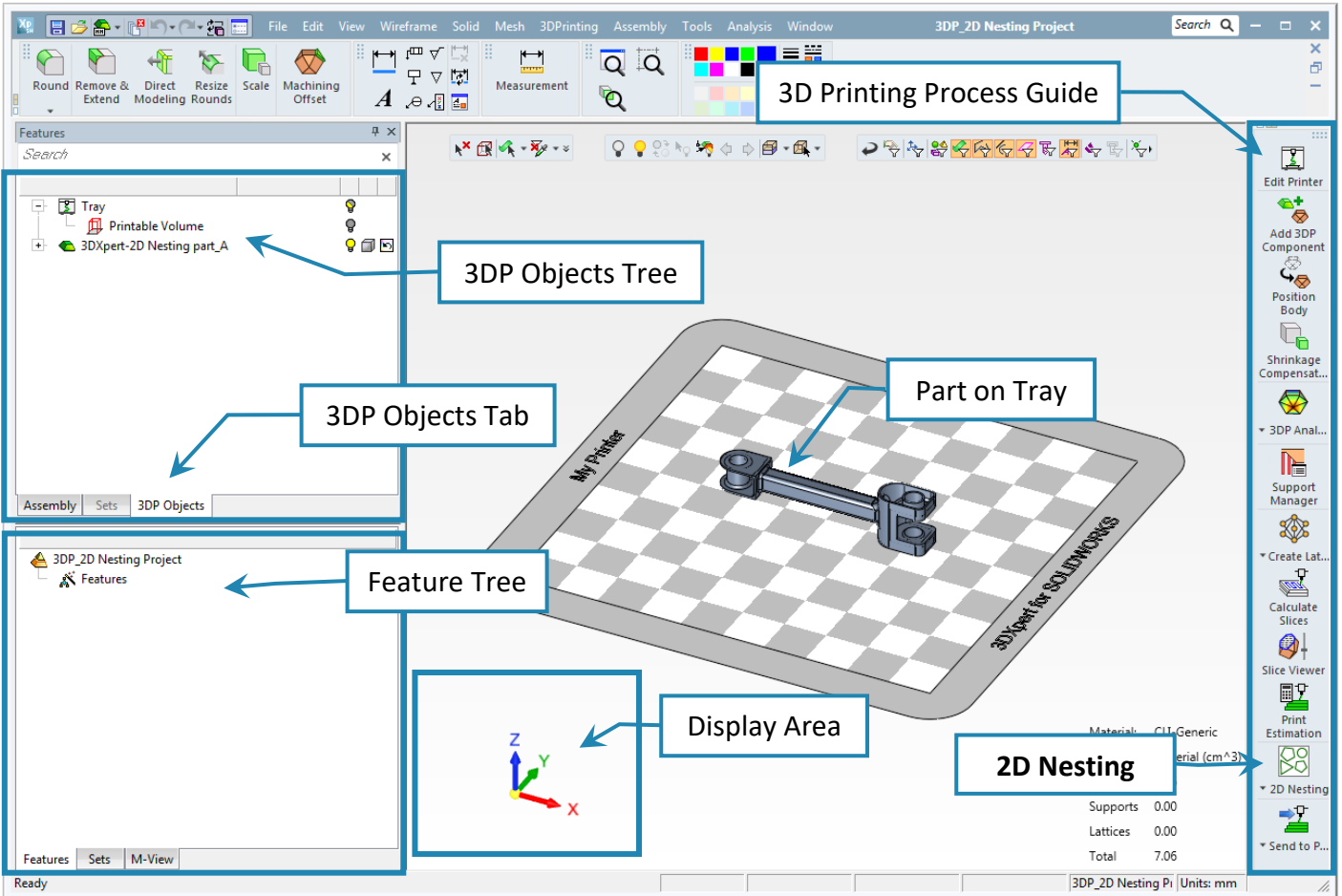



After the file is open, the screen will look like this:

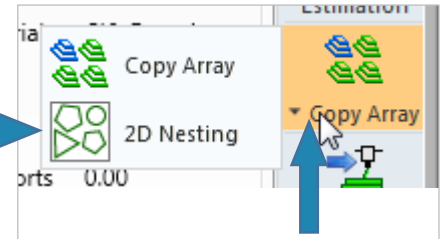

3. From the **3D Objects Tree** hide the Printable Volume (*pick* the yellow bulb to hide). This hide the red wireframe which represents the printing volume.

4. **2D Nesting** is located in a sub menu on the 3D Printing Process Guide. To access this command, hover the mouse over the ▼ sign, the sub menu opens, *pick* the **2D Nesting** command.



 2D Nesting Required: [Icon] [Icon] Optional: [Icon] [Icon]	 2D Nesting 1) <i>Pick</i> components for nesting 2) Define nesting parameters To move from step 1) to 2) press Exit
	No "Preview" for this command
	To approve and finish use the "OK"
	To approve and continue use the "Apply" .
	"Cancel" – exit the command without keep changes

Note that **2D Nesting** is an analysis command, the preview is automatic, or "On Fly".

5. **Pick** the part on Tray and then Exit.

Set parameters to **Minimal Distance=10.0** and **Rotation = OFF**.

Minimal Distance defines the minimal Distance between the parts while calculate the position.

Rotation OFF Do not rotate the nested parts.

Rotation ON Rotate the nested parts.

Pick Start Calculation.

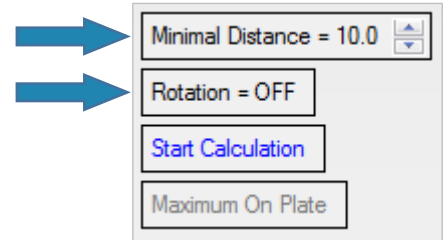

Maximum On Plate Is grayed out and is an informative feature only.

The display is toggled between **Best Fit** and **Maximum On Plate**, depending on the selection in Step 1. If only one part was selected in Step 1, the display is set to **Maximum on Tray** after the nesting calculation.

If more than one part was selected in Step 1, the display is set to **Best Fit** after the nesting calculation.

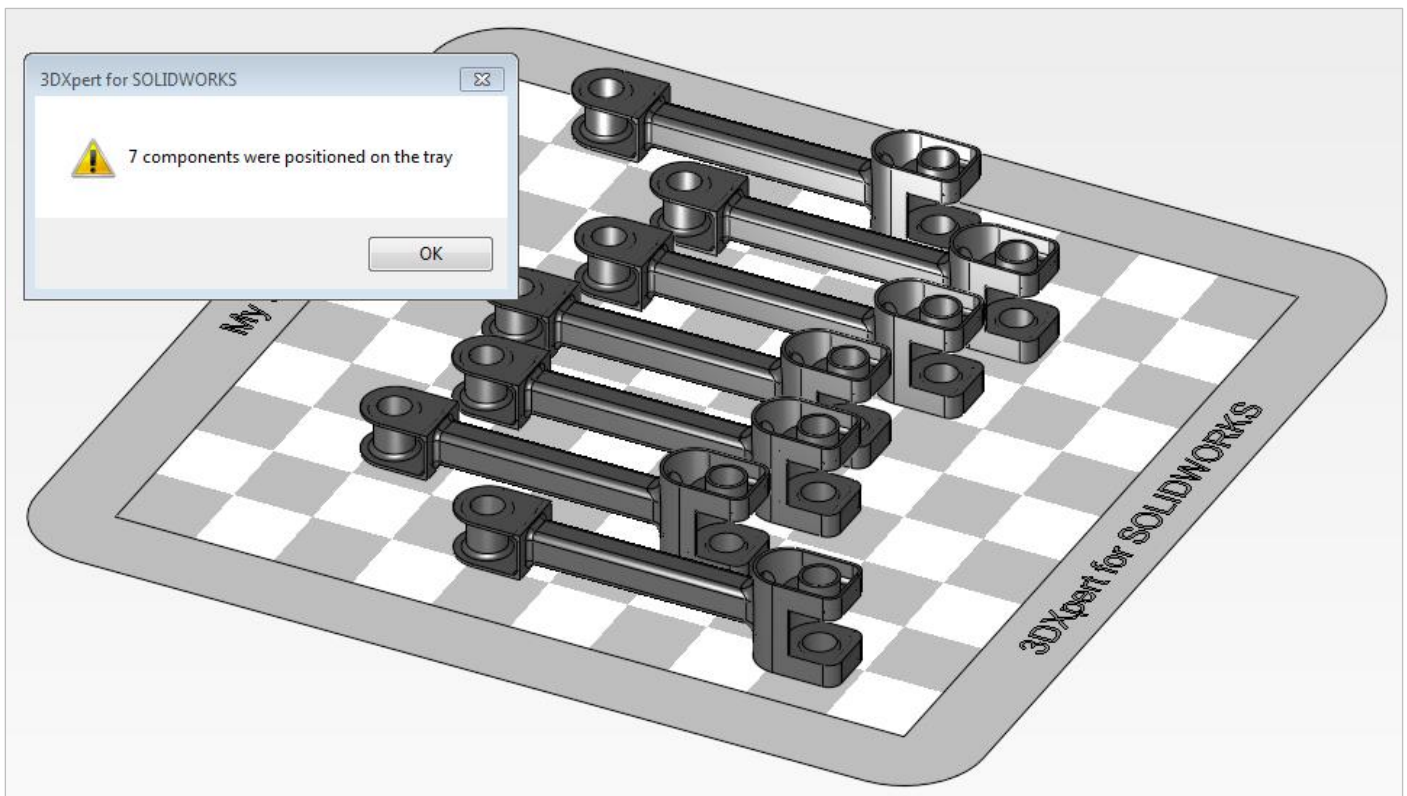

Note the message, specifying that 7 components were positioned on tray in this orientation, **Pick OK**.

6. Change parameters to **Minimal Distance=1.0** and keep **Rotation = OFF**.
Pick Start Calculation.

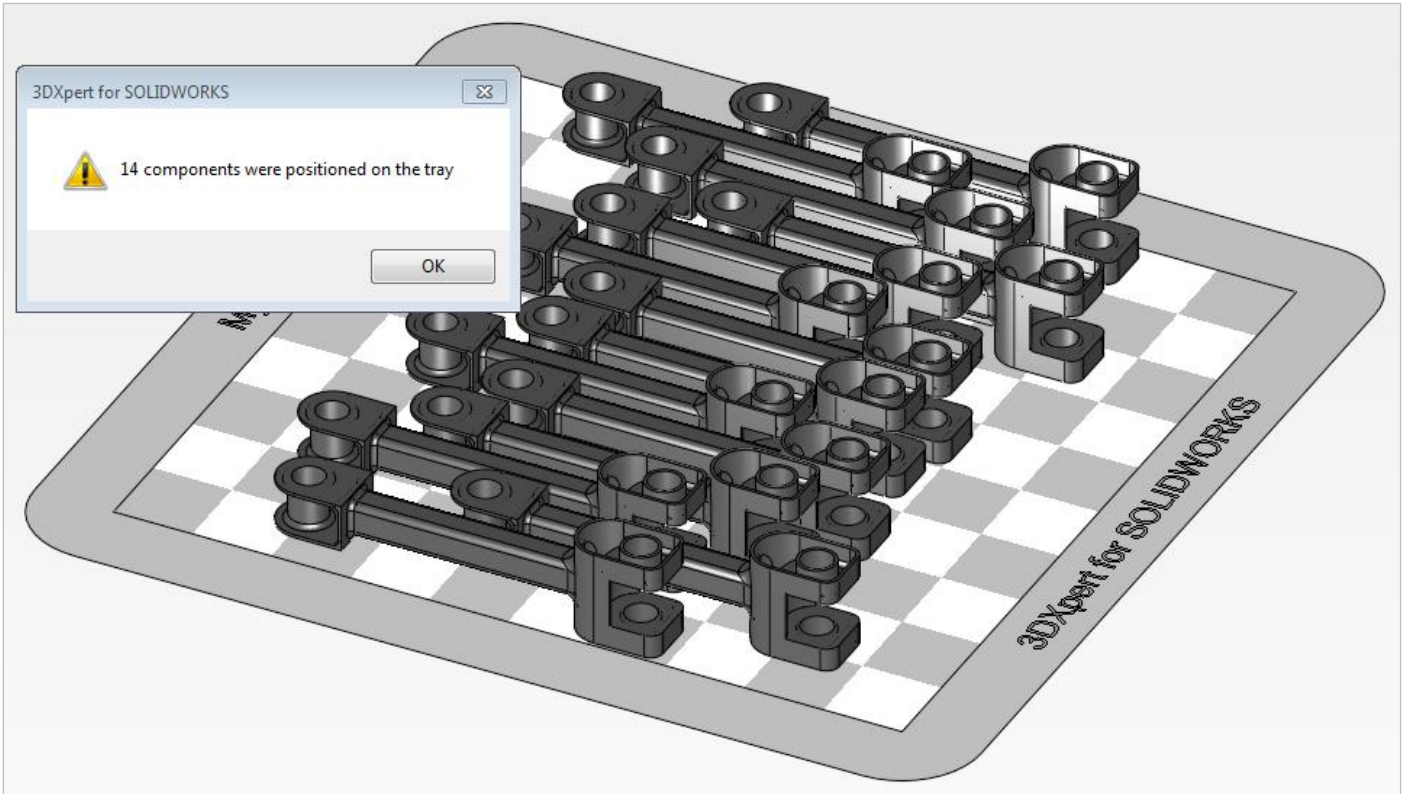
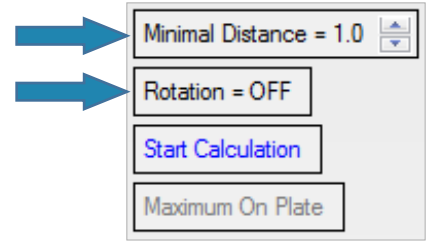

Note the message that 14 components were positioned on tray in this orientation, **Pick OK**.

Cancel  to exit the command without keeping changes.

7. **Pick Add 3DP Component**  from the **3D Printing Process Guide**.

This command will open the **3DXpert for SOLIDWORKS Explorer**.

Load project file **3DXpert-2D Nesting part_B.elt** from the same folder where the downloaded file exist.

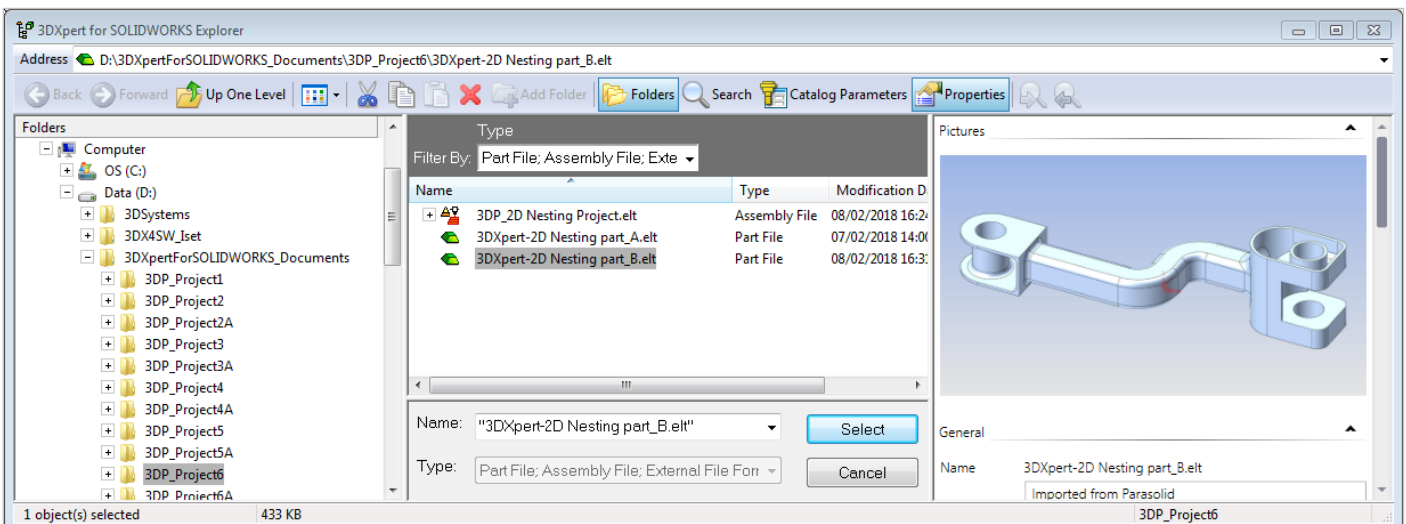

Keep Original Orientation and OK.

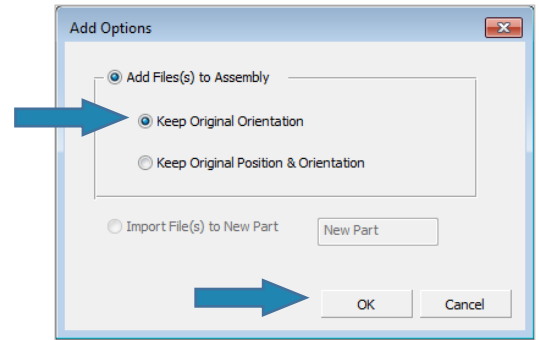

After the file is open, the screen will look like this:

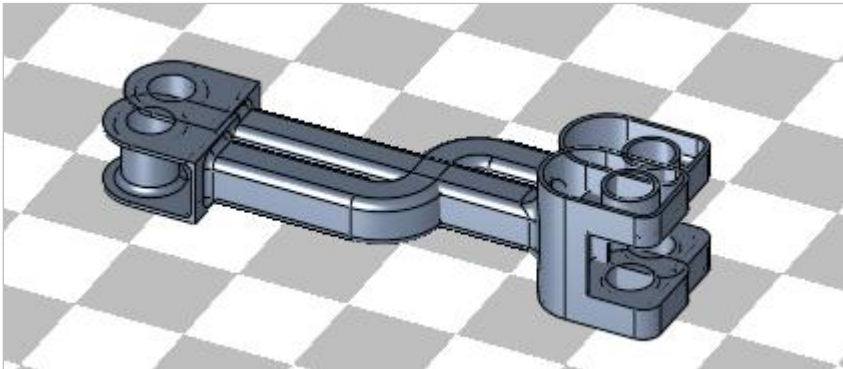

8. **Pick 2D Nesting** command.

9. **Pick** the two parts on Tray and then **Exit**.

Set parameters to **Minimal Distance=1** and **Rotation = OFF**.

Note, Since more than one part was selected in Step 1, the display is set to **Best Fit** after the nesting calculation and it is informative only.

Pick Start Calculation.

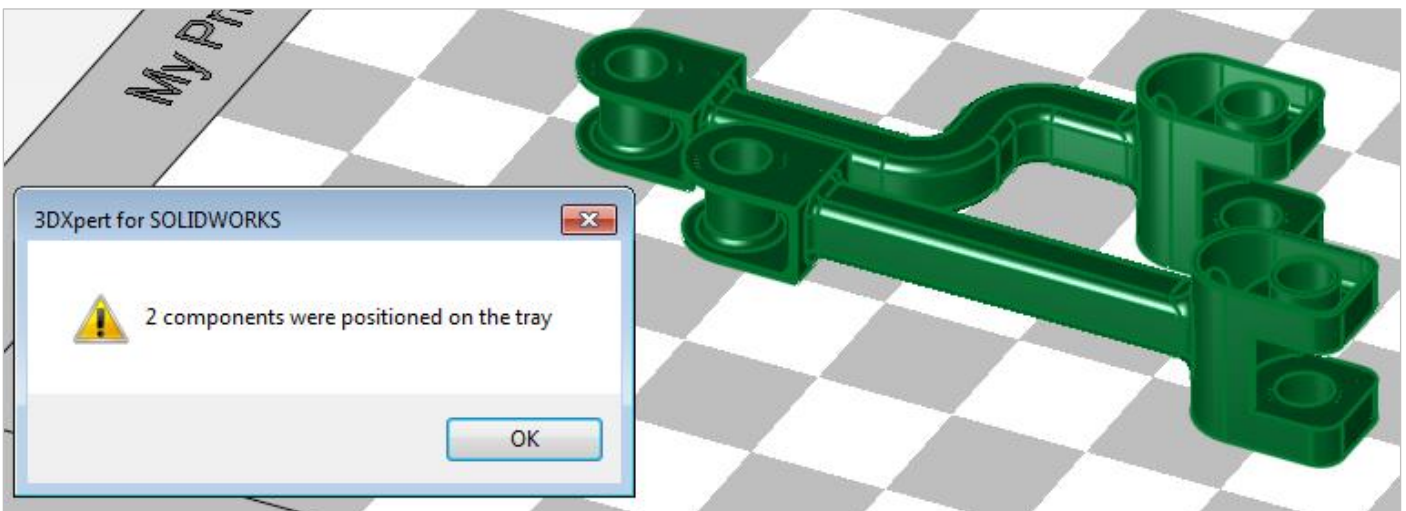
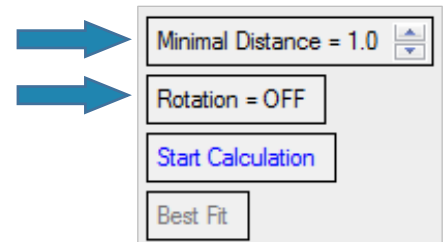

Note that in this case (of more than one part), 2D Nesting is only arranging the parts on tray, **Pick OK**.

End of Exercise.

Appendix –

Here is a sample of 4+4 parts are being nested (the two parts were copied using the **Copy Array** command).

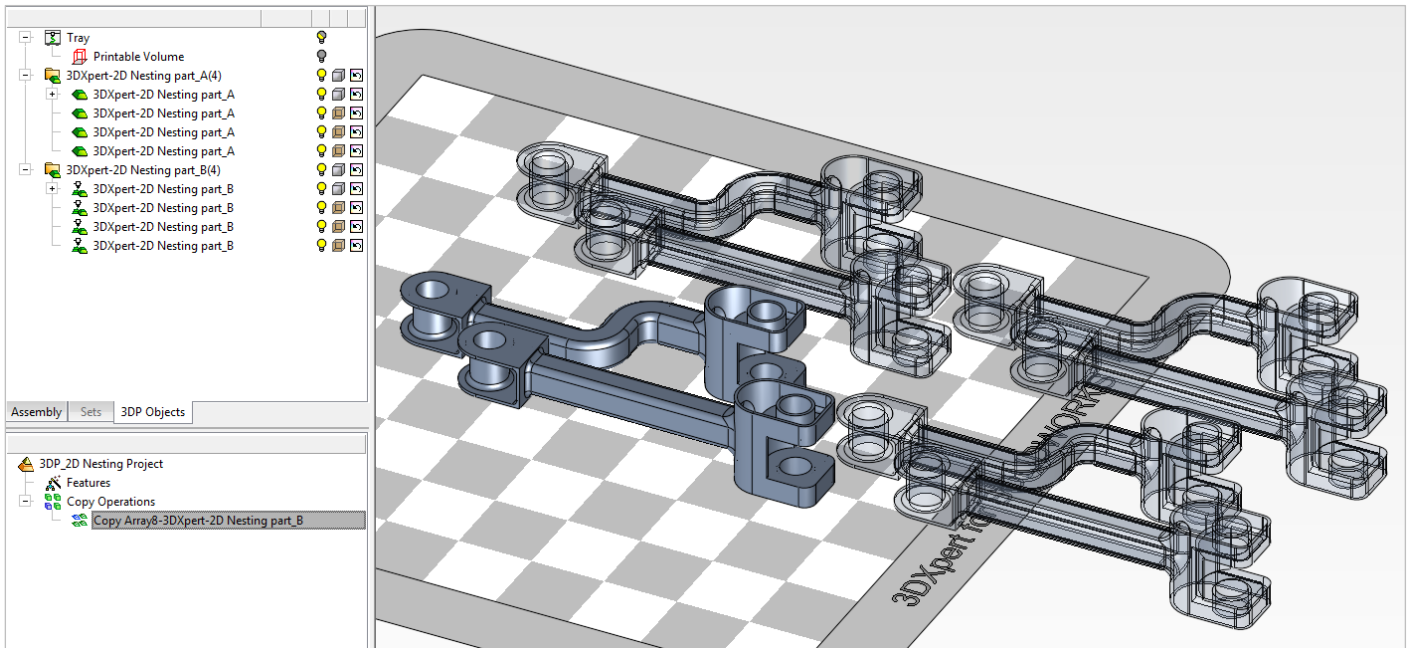

Then 2D Nesting has been executed on all parts:

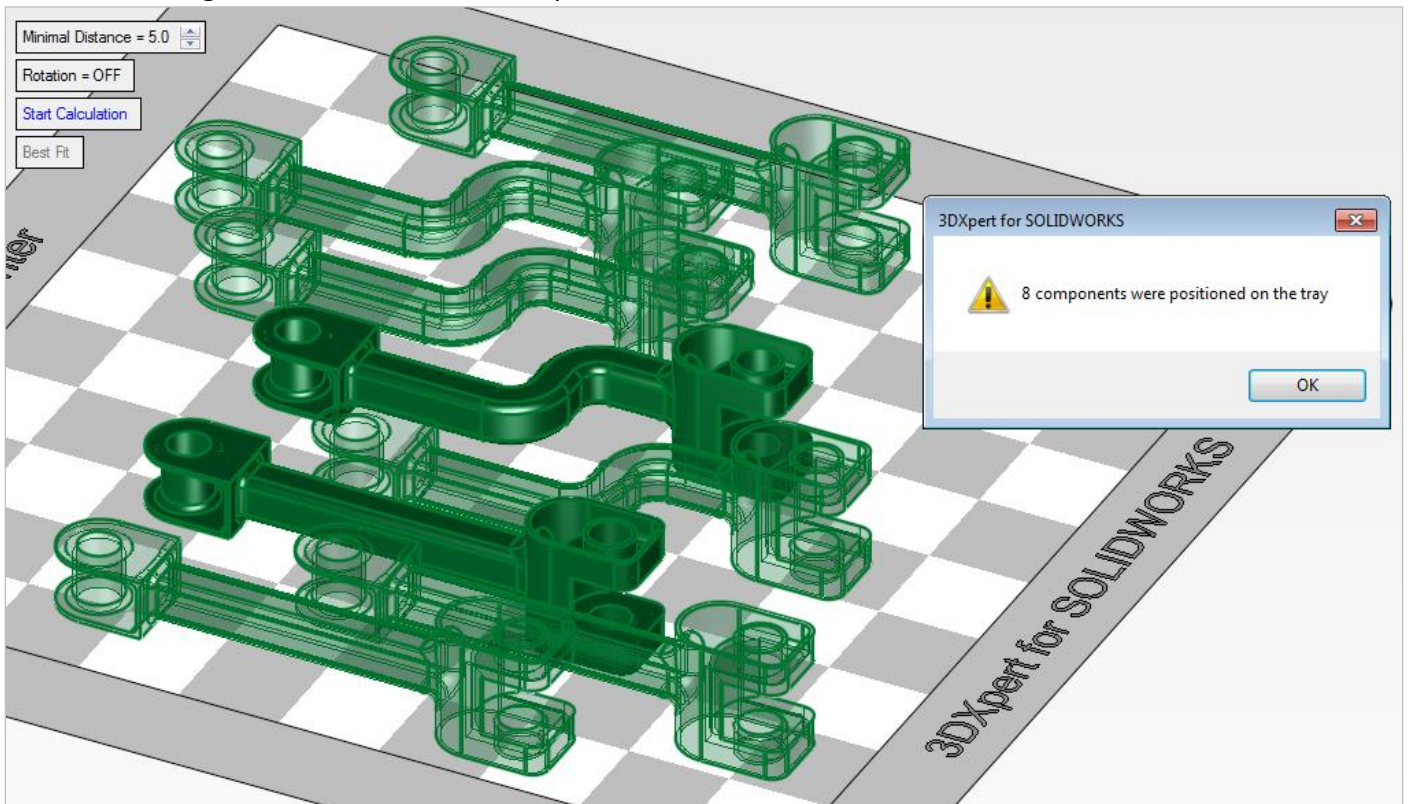

In case that not all the parts can be nested on the tray, a relevant message will appear and the rest of the part remain out of tray (these parts can be removed):

