



**3DXpert™ for SOLIDWORKS®**

# **Create a 3D Printing Project**



## **New Project-set part on Tray**

Tutorial S3: 14,0200,1606,1028(SP2)

In this exercise, we will learn to create **New Project-set part on Tray**.

To create a new project and set the tray we need to follow few steps:

- Load **Manifold\_05\_E1.SLDPRT** to SOLIDWORKS
- Launch **3DXpert for SOLIDWORKS**.
- **Edit Printer** – If needed – *pick* a printer, set the printer's parameters and material.
- **Position Body** – move and rotate the body to fit 3D printing considerations using dedicated analysis tools.

<p style="font-size: 2em; margin: 0;">!</p> <p>Notice/ Remember</p>		Left mouse button name is " <i>pick</i> "
		Middle mouse button name is " <i>Exit</i> "
		Right mouse button name is " <i>Click</i> "

1. Load **Manifold\_05\_E1.SLDPRT** to SOLIDWORKS from the folder that it was downloaded to.

2. From the Additive Manufacturing tab *pick* **3DXpert for SOLIDWORKS** command.

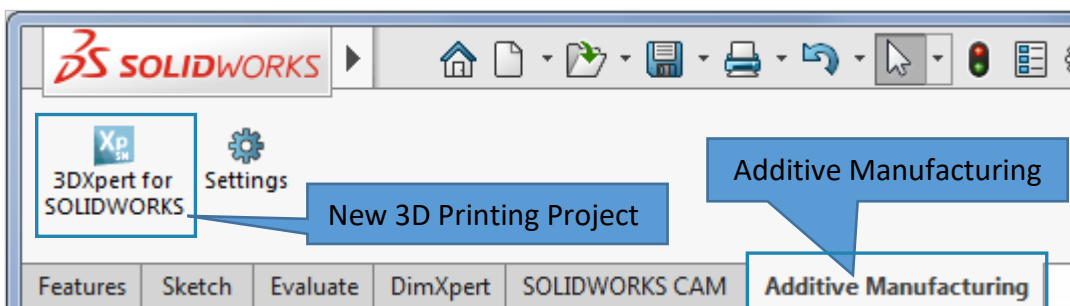
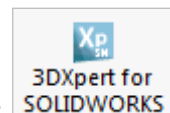

This command will launch **3DXpert for SOLIDWORKS**.

3. After the **3DXpert for SOLIDWORKS** new window will open:

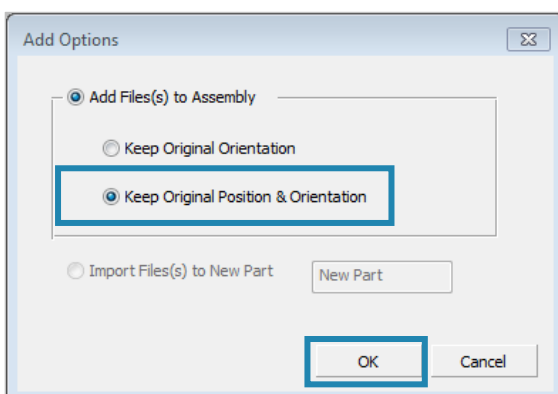

*Pick* **Keep Original Position & Orientation** and **OK**:

In this window we set the basic positioning of the part on the tray

- **Keep Original Orientation** means that the part will not rotate to any direction - XYZ of the part will be parallel to the XYZ of the tray - but the center of the bounded silhouette will move to the center of tray.
- **Keep Original Position & Orientation** means that the part will not rotate to any direction - XYZ of the part will be parallel to the XYZ of the tray - but the center of the part (UCS 0,0) will move to the center of tray.

After the file is open the screen will look like this:

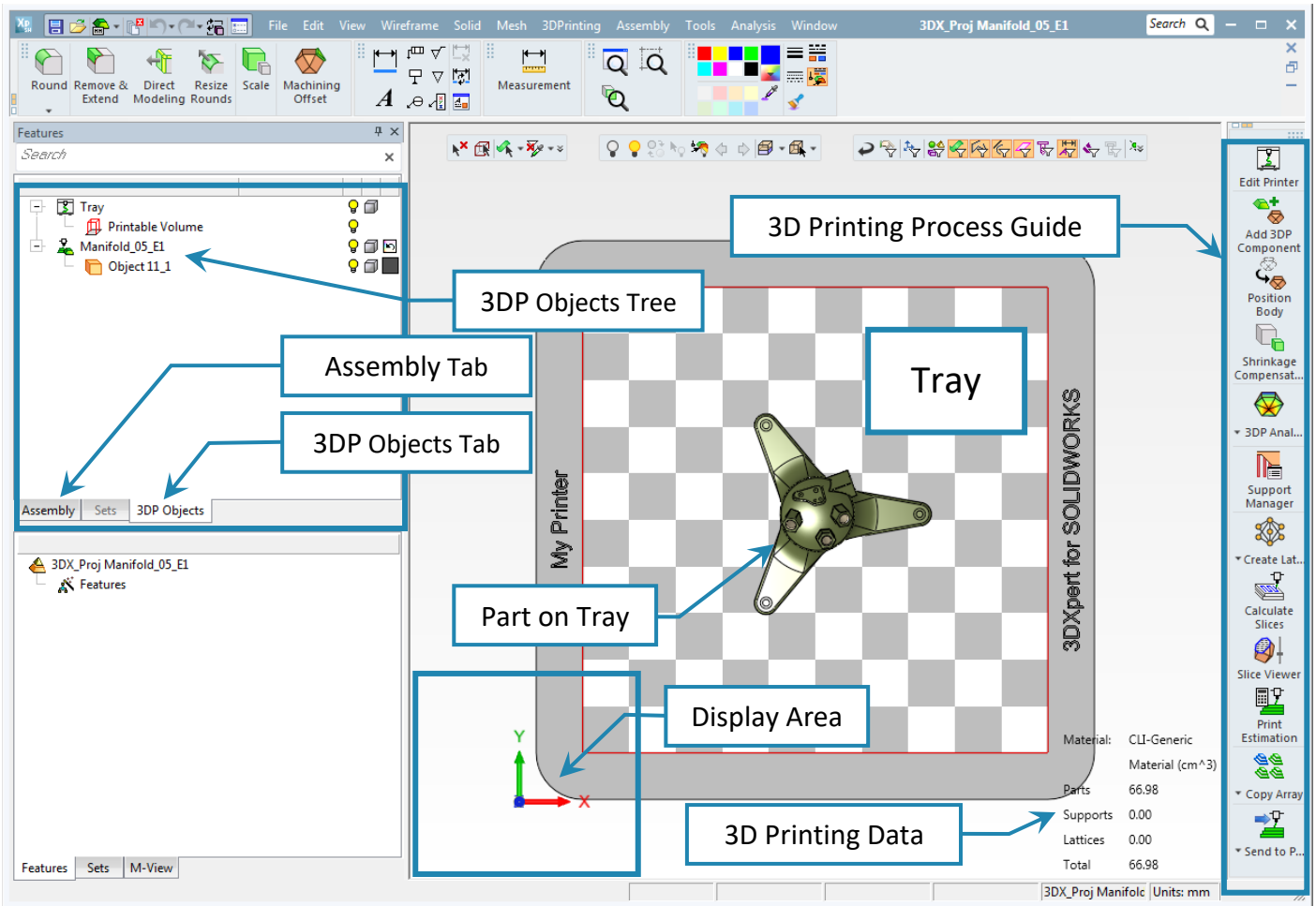

Notice the Process Guide on the right side of the screen. This guide contains most of the functionality to enable preparing the part for printing.

4. Save the project, pick the Save  command on top left corner.

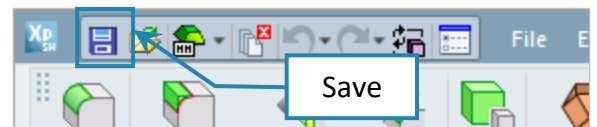

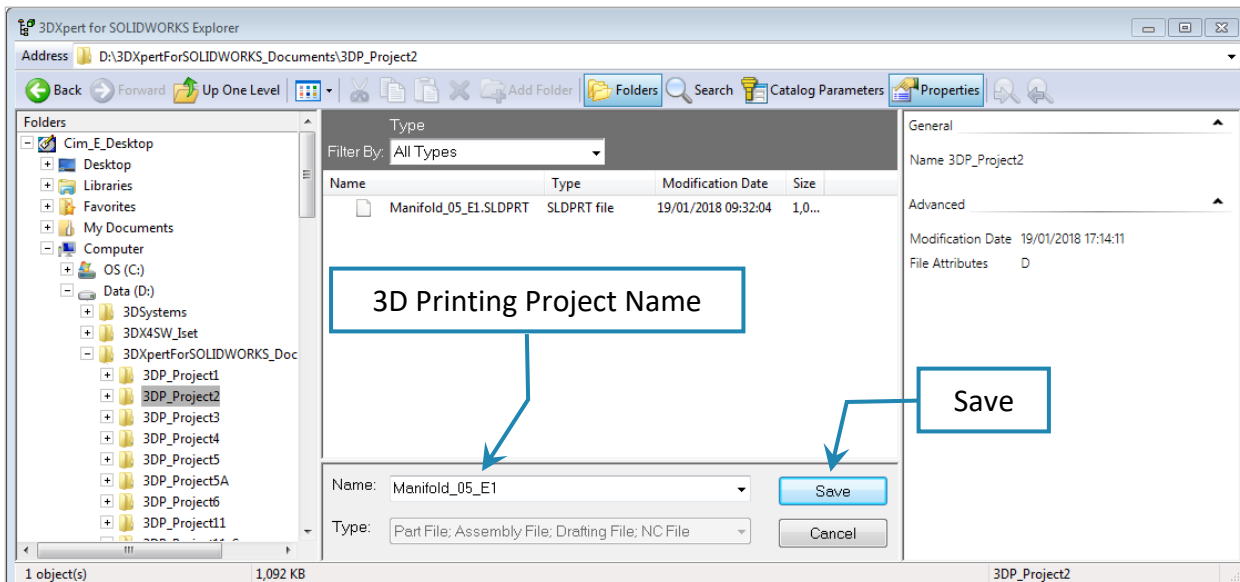

This command will open the **3DXpert for SOLIDWORKS Explorer**. Save the file to the same folder with the downloaded files.

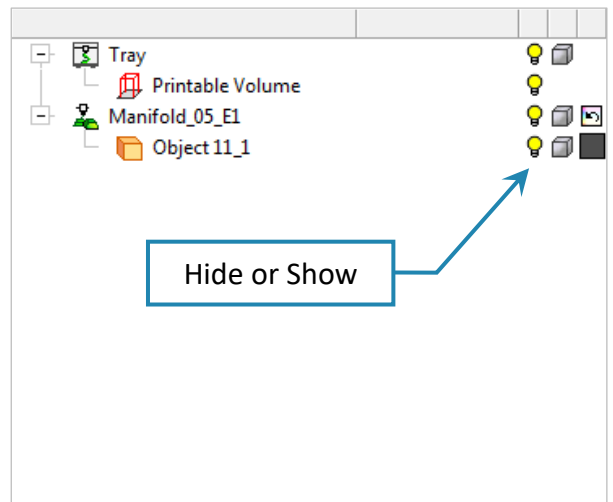

In the **3DP Objects Tree** it is possible to see that an object named **Tray** was automatically add to the tree, the **Tray** represents the printing area of the selected 3D printer.

For a clear view of the part, you can always hide or show the tray by pressing the bulb alongside the Tray part in the project's tree. This is also applicable for any other parts that we may add later on.



5. From the 3D Printing Toolbar **pick** the **Edit Printer**  command,

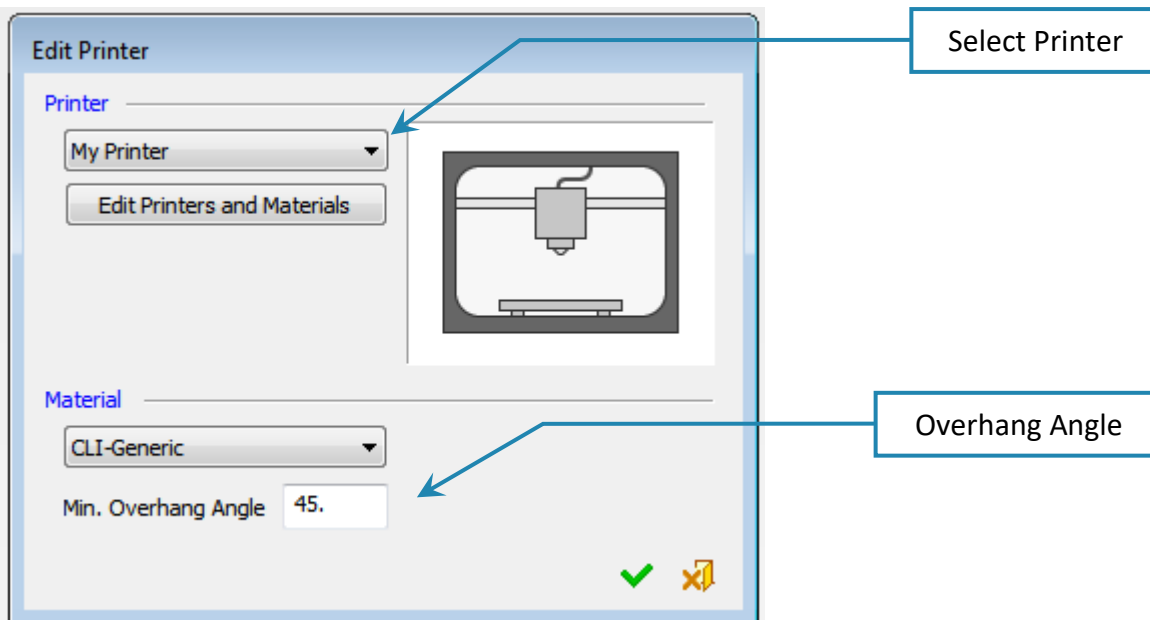

**!** Please notice: **My Printer** is used for this exercise as well as **30° Overhang Angle**.

6. **Pick** the **My Printer** button  and look at the list of printers.

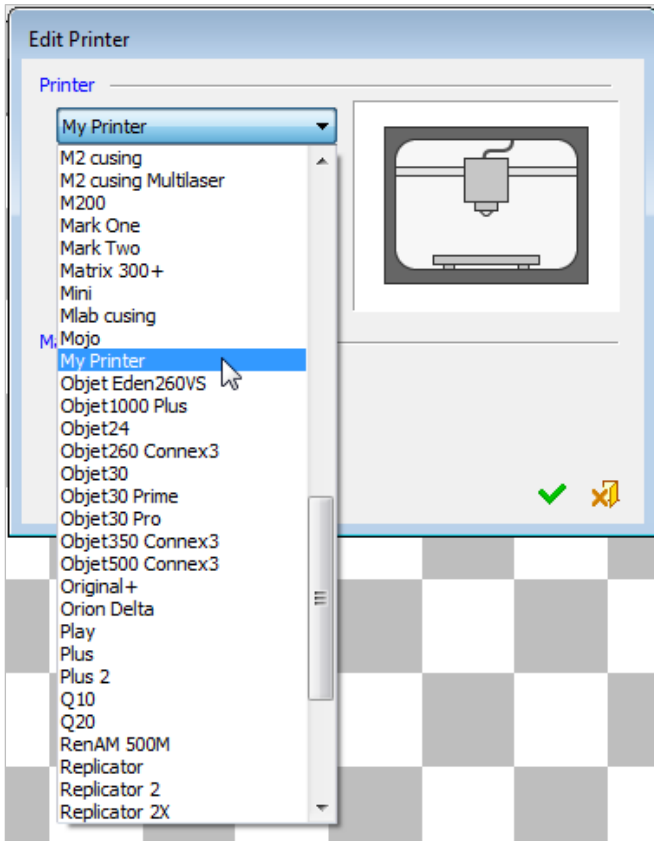

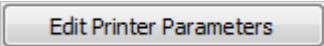
7. **Pick** the **Edit Printer Parameters** button  and a new window will open:

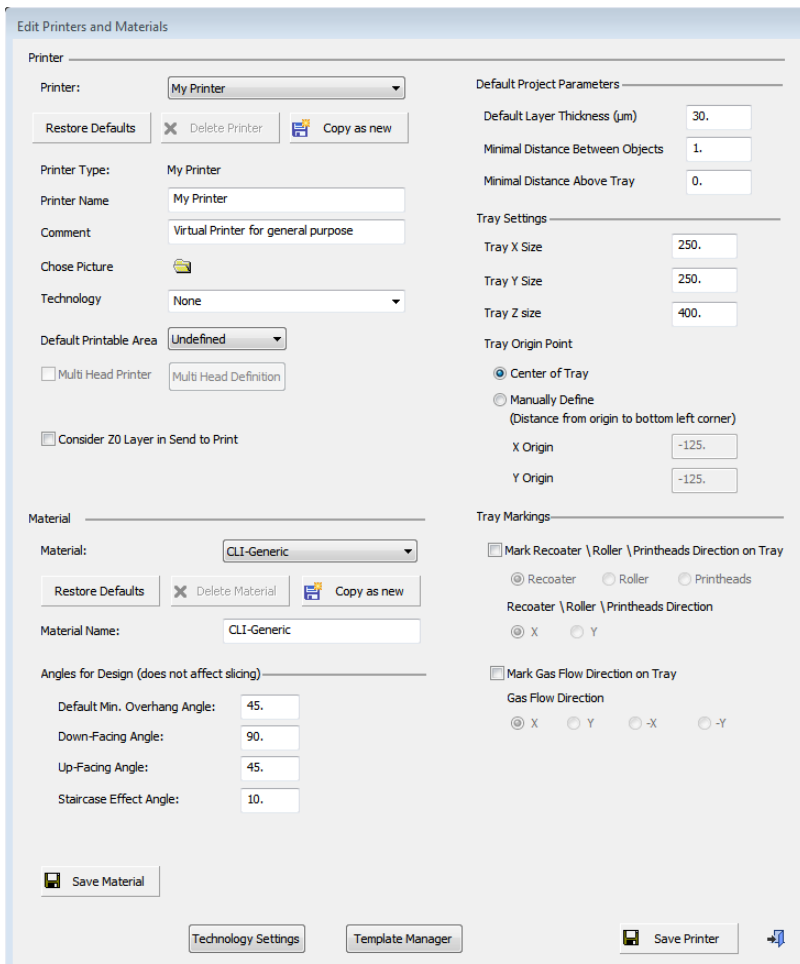

From this window it is possible to edit parameters to current or define a new printer, starting from the printer name, printer picture, printer volume and more.

8. After adding the **3DP component** the tray will lock like this:

From a TOP view

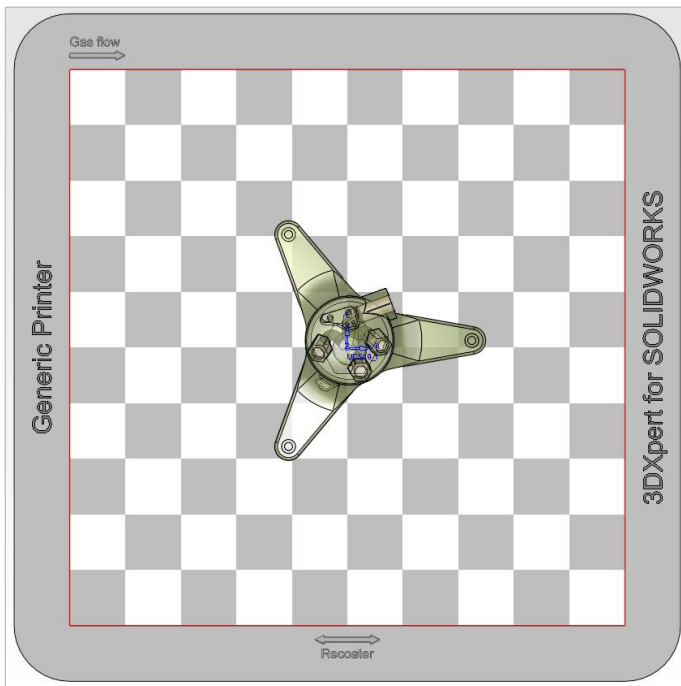

From ISO view

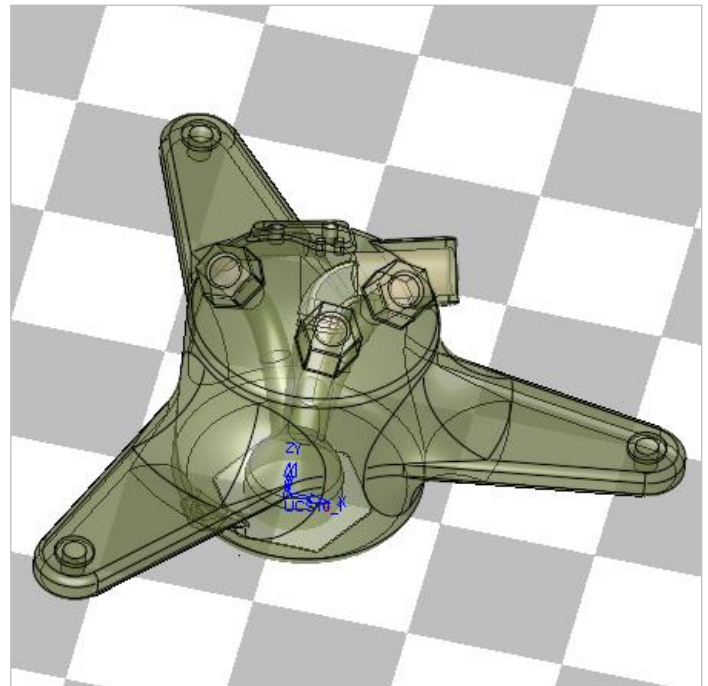

Rotate the display and or use Dynamic UCS (display area bottom left) to view the position of the part.

9. Click (right mouse button) on the **X** axis of the Dynamic UCS to see that part of the body is under the tray, this will be fixed in the next step of positioning the body.

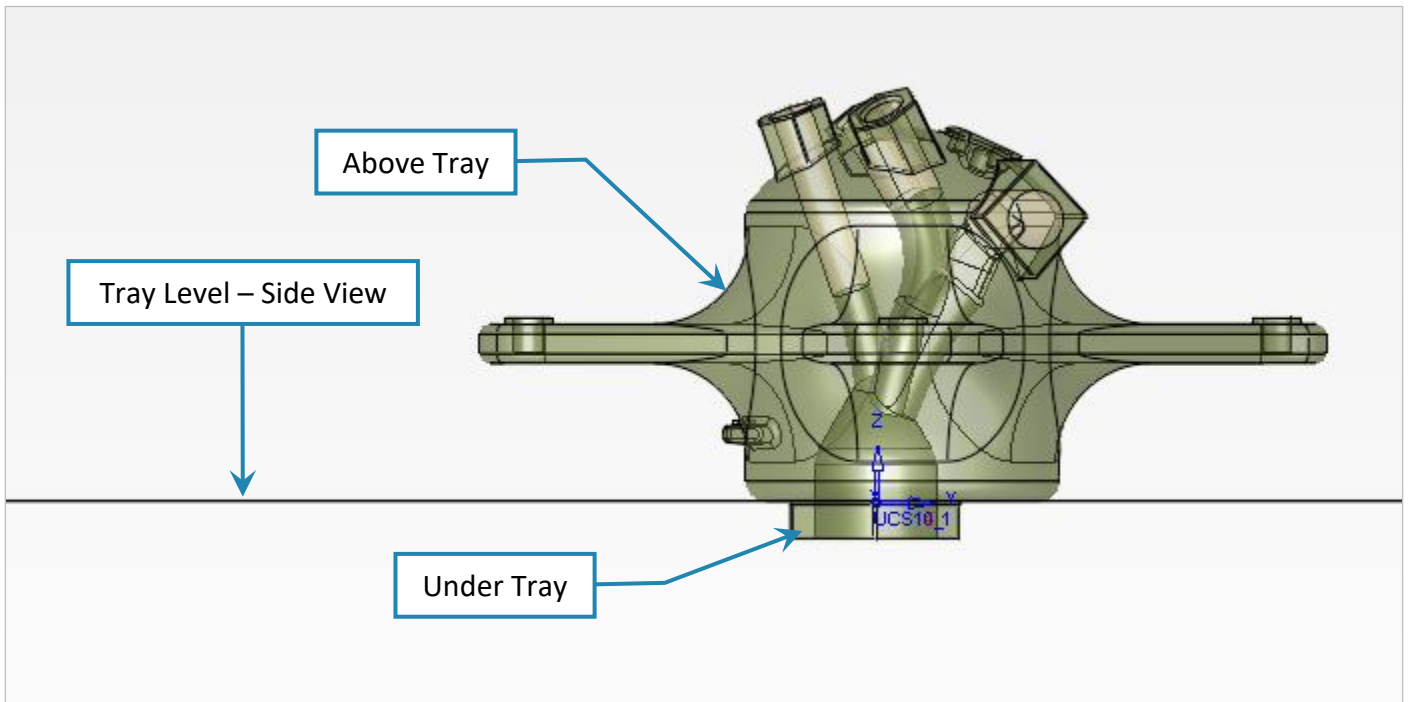



10. **Pick** the **Position Body** command,

	<b>Position Body</b>	
	1) <b>Pick</b> object 2) Position Body	
		<b>"Preview"</b> the result without executing
		To approve and finish use the <b>"OK"</b>
		To approve and continue use the <b>"Apply"</b> .
		<b>"Cancel"</b> – exit the comand without keep changes

The first thing that happen is that the body "jumps" so the lower point of the body will be at tray level. Above Tray parameter always keep the body above Tray level (Z=0).

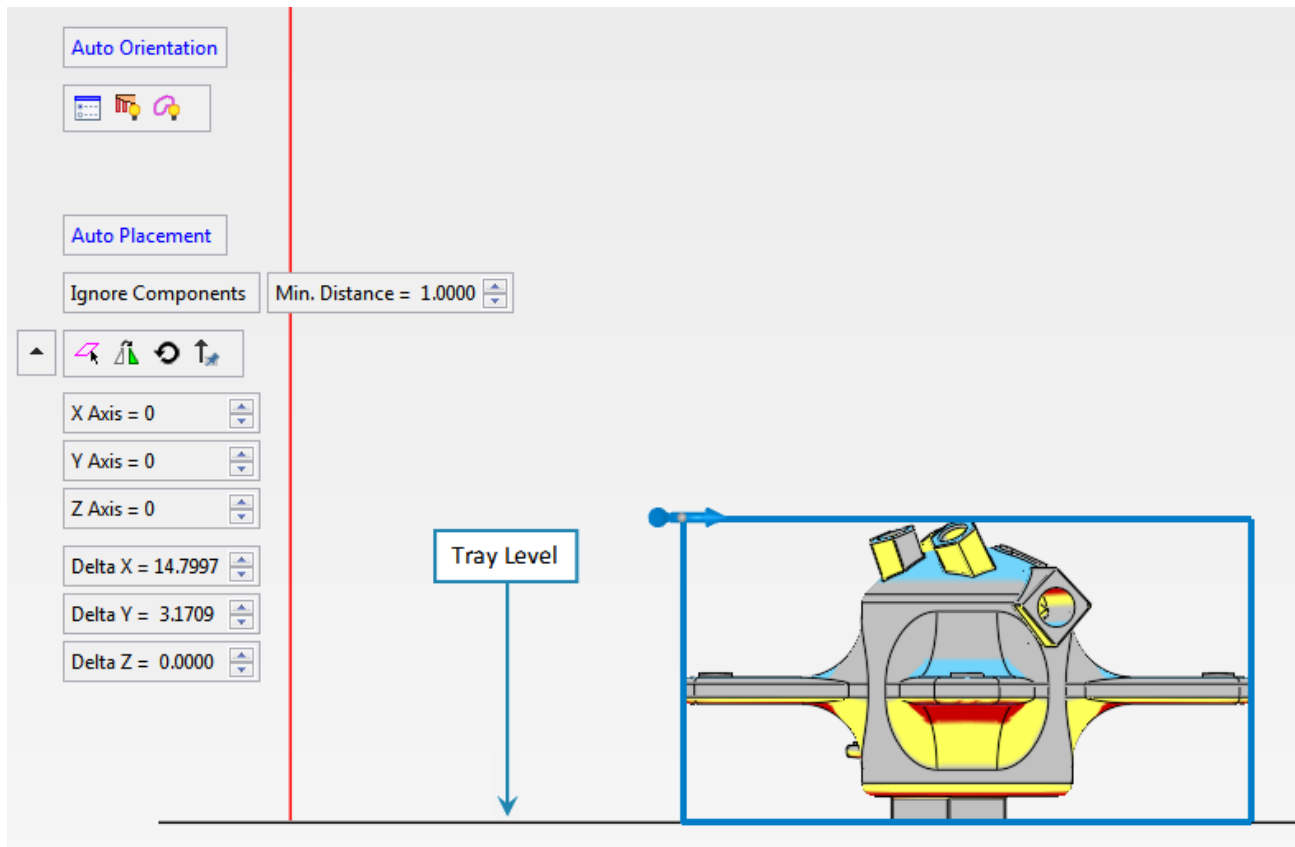

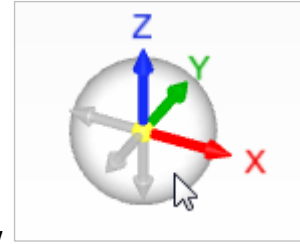

At this stage click the dynamic UCS anywhere on the white ball for ISO view

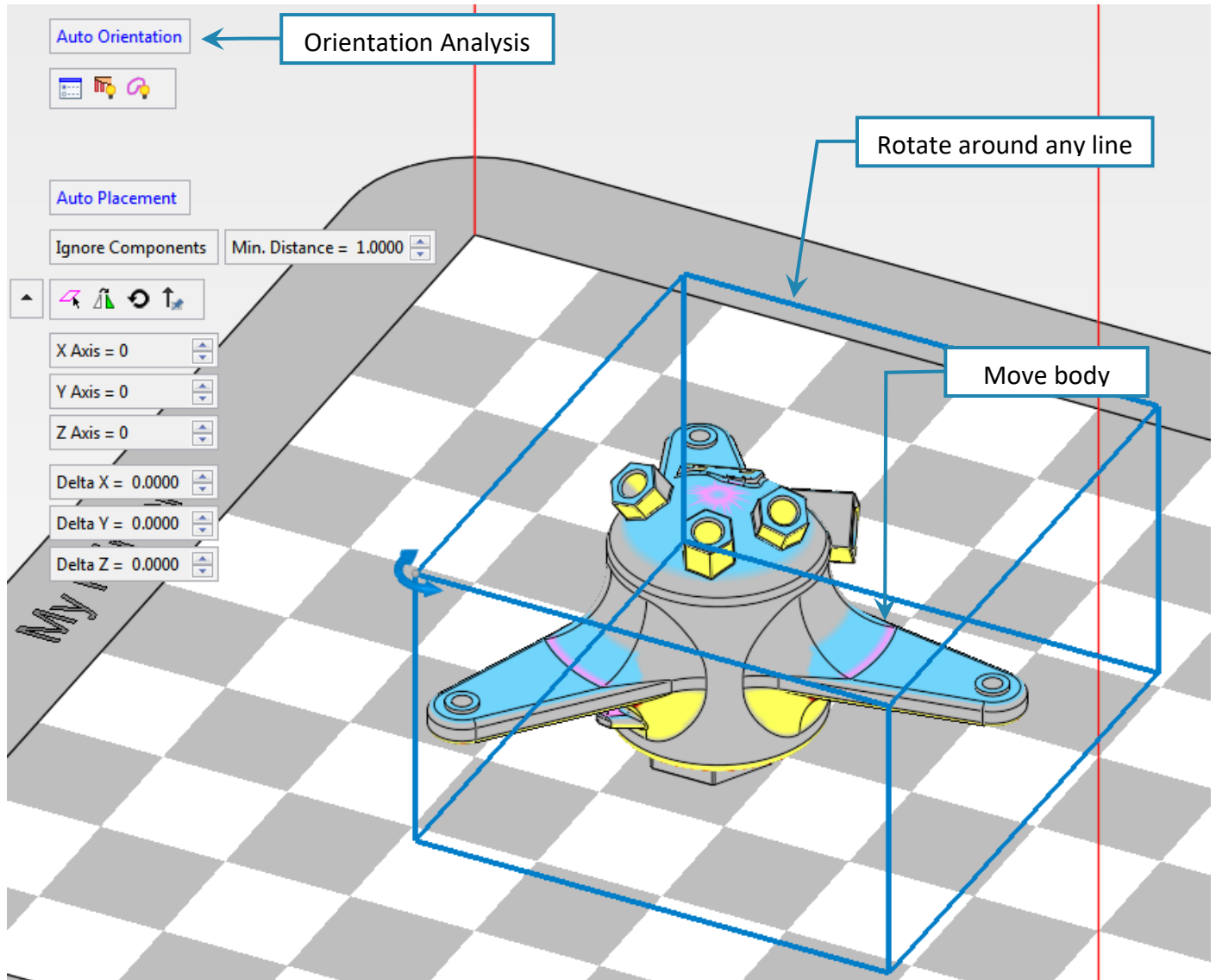



The bounding box (together with the part) can be moved and rotated either dynamically or by selecting the relevant parameters. To move the box dynamically, pick the part and drag it around the tray; to rotate the box, pick any of the edges of the box and drag it to rotate it.

To move the box dynamically, **pick** the part and drag it over the tray.

If **Consider Components** option is selected, the part cannot escape the boundaries of the printable area of the tray.

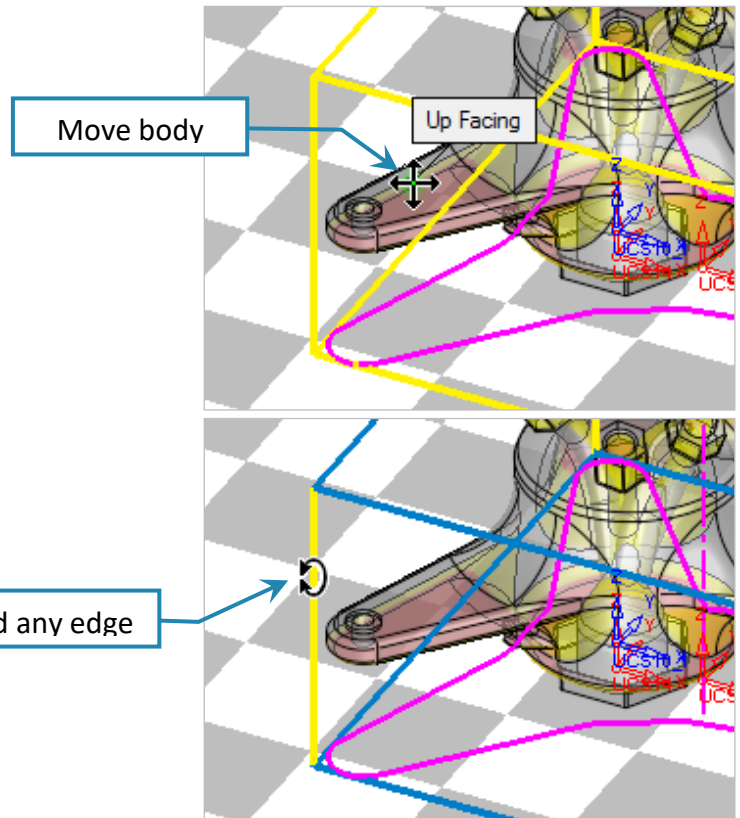

To rotate the box, **pick** any of the edges of the box and drag it to rotate it.

If **Consider Components** option is selected, the part cannot escape the boundaries of the printable area of the tray.

If that happens during rotation The part "jumps" up above the tray.

**Orientation Analysis** pressing the button will show several orientation methods.

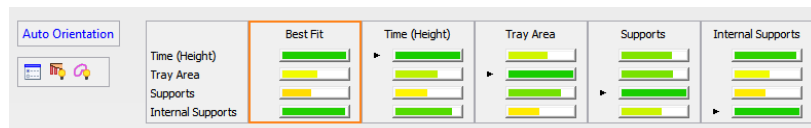

**Pick Auto Orientation** button to start analysis after selecting the required method.

**Overhang Angle** defines the degree of overhang after which some support structure should be added to areas of the Body.

The angle is measured from the horizon and was set at **Edit Printer** stage. It is possible to change the angle at any time also in **Position Body** command.

The **Auto Orientation** takes the **Overhang Angle** in consideration while analyzing.

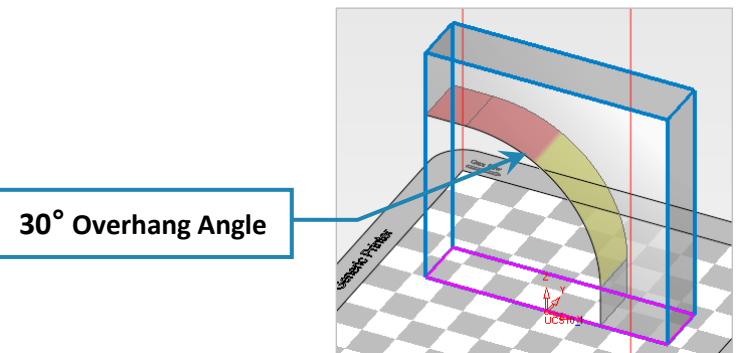

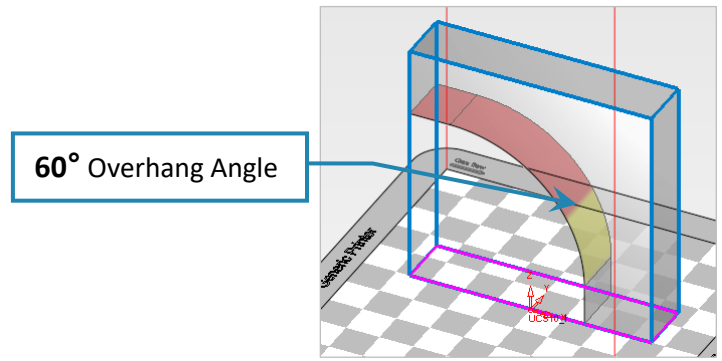

**Reset Orientation** allows at any time to reset the body Orientation to the same Orientation like when the part was added.

**Flip** rotates the body upside down (and vice versa).  
 Auto Placement allows to position the part in the center of the tray without changing the **Orientation**.

End of Exercise.